

## Rotational geometry as a teaching tool: applying the work of Giorgio Scarpa

Pino TROGU\*

San Francisco State University

**Abstract:** *This paper focuses on a teaching unit in drawing for design that uses and applies Giorgio Scarpa's principles and methods in rotational geometry, as put forth in his book *Modelli di Geometria Rotatoria*, (*Models of rotational geometry*, 1978), and tests their validity through the construction of physical models built by the students. These models are derived from the sectioning of regular polyhedra such as the cube. The resulting modules can be re-configured into closed or open "chains" capable of folding back into their original minimal volume. This process has parallels in geometric folding, such as in linkages, origami, and polyhedra theory in general. This paper will introduce Scarpa's work to English-speaking specialists, and will illustrate how the subject can be made useful to design students.*

**Keywords:** *rotational geometry, drawing, design, geometric folding, linkages, origami, polyhedra, chain.*

---

\* Pino Trogu: Department of Design and Industry/College of Liberal and Creative Arts | San Francisco State University | USA | e-mail: [trogu@sfsu.edu](mailto:trogu@sfsu.edu)

Genesis of form. Motion is at the root of all growth  
—Paul Klee

Although rotational geometry is a difficult field of mathematics available only to specialists, the physical models that apply its principles are highly useful for courses in sketching and drawing. Students at San Francisco State University have found rotational geometry to be one of the most valuable segments of the drawing course, offering such remarks as: “I feel that this project used all of the skills that we learned in class, from drawing the basic shape in orthographic and isometric views to the cubic modules in the perspective.” “This project challenged my design thinking by taking a 2D object and rendering it in a 3D environment.” These were characteristic responses to the query: “Which class project did you find the most beneficial to your learning?”

The segment of the course is based on the writings of the Italian scholar Giorgio Scarpa (1938-2012). This paper will introduce his work to English-speaking educators, and will illustrate how the subject can be made useful to art and design students both in high school and at the college level.

Giorgio Scarpa taught Descriptive Geometry at the Istituto Statale d’Arte of Oristano and Faenza, Italy, and Theory of Perception at the Istituto Superiore Industrie Artistiche (ISIA) in Faenza. His book *Modelli di Geometria Rotatoria* (Scarpa 1978), which was part of a design series edited by the late Italian designer Bruno Munari, is the basis of this study. This paper focuses on a teaching unit in drawing for design that uses and applies Scarpa’s principles and methods, which were in turn inspired by the Bauhaus lectures of the painter Paul Klee and published after his death (Klee 1961, pp. 126-27). The unit tests the validity of the method through the construction of physical models built by the students. Through this process, students learn to apply a visual grammar based on rotational movements and folding which transforms two-dimensional shapes into three-dimensional solids. These solids are modules derived from the sectioning of regular polyhedra such as the cube. In theory, any regular solid can be used as the basis for the section. In this study only the cube is used, due to its simple and intuitive symmetry.

Drafting and Sketching for Design is a required course for all students entering the Design and Industry Department at San Francisco State University. In the class, all drawing is done by hand with drafting tools and free hand sketching. These students will become graphic designers, product designers, digital media designers, and creative professionals in general. The class covers orthographic projections, isometric projections, and perspective.

The unit called Cube Section begins with the simple problem: dissect a 4” x 4” x 4” cube into two or three solid modules having identical surface area, volume, and shape. At a later time, the three-dimensional modules that will form the final cube will be connected with hinges. The connected modules can be arranged into open or closed chains. The modules may or may not fold back into a minimum volume depending on the type, location, and orientation of the hinges. The materials used in this process are pencil, paper and tape or glue. While the students are able to improve their manual skills through the use of these materials, the use of CAD and 3D printing at a later stage will allow for quick testing of the various configurations.

The process for the section that divides the cube into two modules will be called the “twin” section. The process that divides the cube into three modules will be called the “triplet” section.

## A. TWIN SECTION

### The process

Given a square 4" x 4" and its modular grid (Fig. 1), we draw a segmented line that divides the face of the cube into two separate parts. This line can be a 2-segment line, a 3-segment line, or more. In principle, any combination of segments can work, but in practice we keep the number of segments to a minimum to facilitate the actual construction of the cube. Additional constraints are: 1. Begin the line at the midpoint of the left edge of the square: point C in Fig. 1.1; 2. End the line at any point labeled C, D, or E on the right edge of the square; 3. The end point of any segment must not fall on the points shown as red dots in Fig. 1.4. This last constraint keeps to two the number of cross-sections that are needed to determine the distances from the points to the center of the cube.

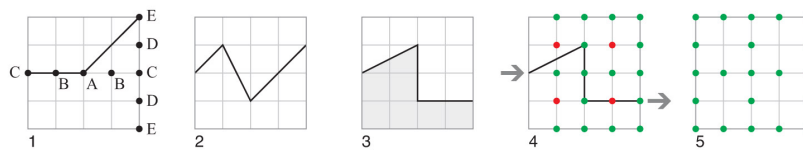

**Figure 1.** The square is sectioned into two parts, starting at the mid-point on the left edge and ending at any point on the right edge, but avoiding “stops” on the four red dots.

We then mirror the original square along its right edge as shown in Fig 2. The right edge is the axis of symmetry. Next we rotate the resulting pair of squares by 180 degrees. We label the points on the section and then we find the distances from those points to the center of the cube with the aid of separate cross-section drawings that are provided to the students. We add a top and a bottom square to complete the external surface of the two-module cube.

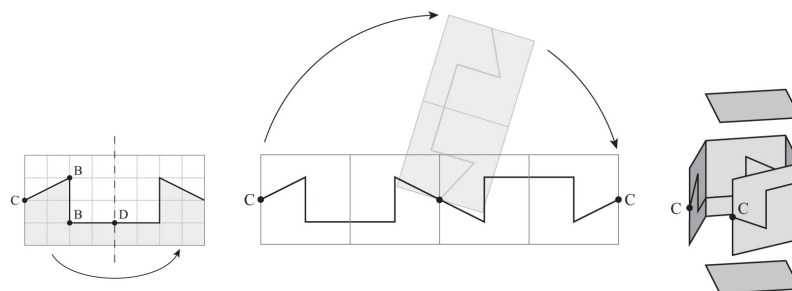

**Figure 2.** Mirroring and rotations of the basic square.

The external surface and the section along the four sides are now determined. The next step is to determine the internal surface of the modules by constructing a series of triangles whose bases are the segments on the faces and whose vertices coincide with the center of the cube (Fig. 3). Each foldout shape is exactly half the external surface of the cube. Each segment along the section will be connected to the center of the cube

to determine the triangles needed for the foldout surface of the internal section. Z: center of cube. BB: base of one of the triangles (BBZ).

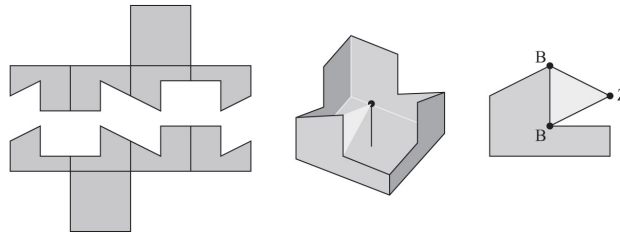

**Figure 3.** At left is the complete template for the outside of the cube.

With the aid of two cross sections, one along the median of the face of the cube, and the other along the diagonal of the face of the cube as shown in Fig. 4.2, we determine actual distances from any end-point of the segment on the face to the center of the cube.

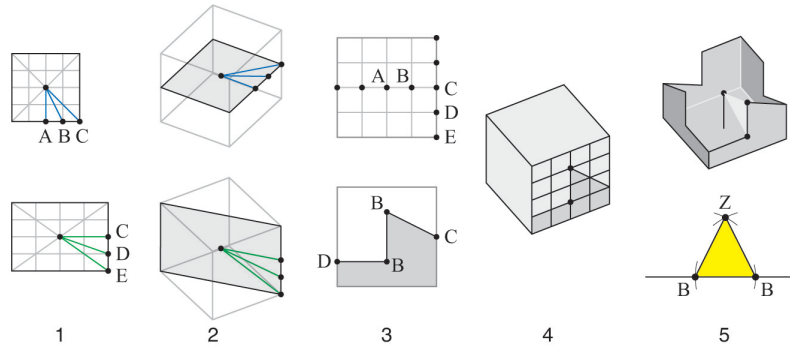

**Figure 4.** The triangles needed for the internal surfaces are constructed from a combination of external and internal lines.

We label the points on the face of the cube from A through E. In the example shown in Fig. 4.3, only points B, C, and D are used. The center of the cube is labeled Z. The two end points of each segment on the face are connected to the center point, forming unique triangles. In the example, two B points are connected to the center of the cube, as shown in Fig. 4.5. By constructing a series of adjacent triangles, we determine the internal surface of the sectioned cube. The resulting flat foldout shape will be folded into the appropriate configuration, matching the center and the segments along the faces. Thus, using ruler and compass, the internal surface of the modules is determined. When folded in 3D space, the surface shown in Fig. 5 will be a dihedral sequence formed by a combination of convex and concave shapes. As a rule, the complete foldout pattern of this internal surface cannot be obtained from a single sheet of paper without overlap. The vertexes of the internal surface, shown in yellow, will be matched to points on the external surface, shown in gray.

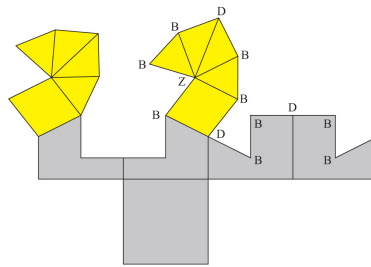

Figure 5. Foldout of internal and external surfaces combined.

When we complete the folding, the two modules are placed side by side to check that they have identical shapes. Both modules are “right-handed” (Fig. 6.6). Typically, a module will display a positive-negative configuration, where the “female” side of the module will fit the complementary “male” side of the other module (Fig. 6.5).

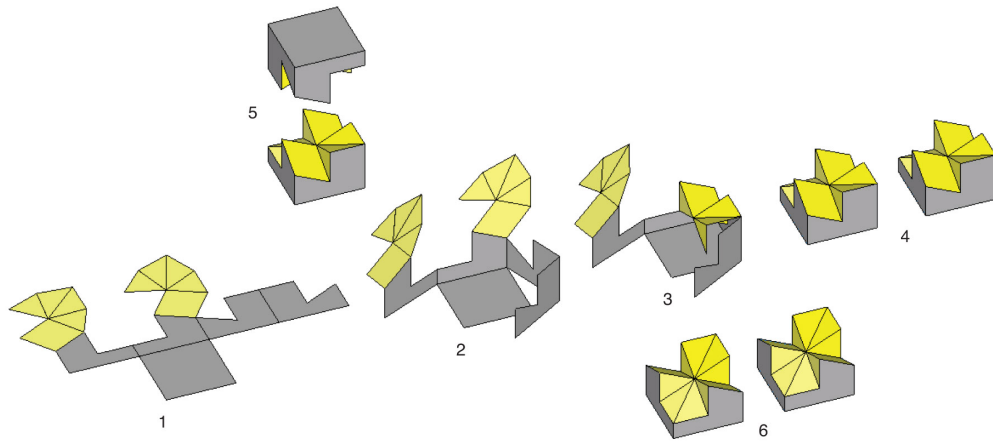

Figure 6. Folding sequence from flat polygon to completed solid.

In the drawing unit, the students also document the modules in a series of drawings, some of which are shown in Fig. 7. All the drawings are done by hand, but the examples shown below were drawn on the computer for ease of reproduction.

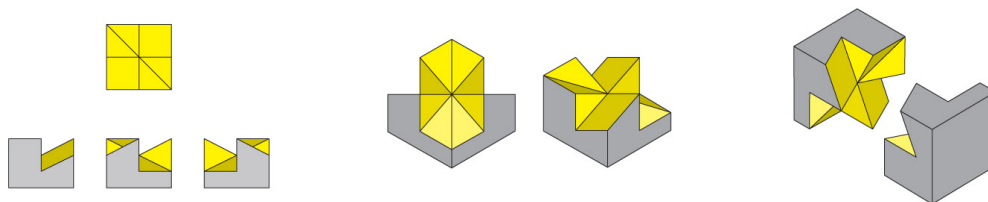

Figure 7. Orthographic and isometric views of the modules.

## B. TRIPLET SECTION

As Italian designer Bruno Munari noted, the close relationship of the cube with the square might appear at first to be counter to a section of the cube into three parts. However, he adds that a cube has six faces, which is divisible by three, and this suggests that such a solution is possible (Munari 1974, pp. 194-97).

In this process we will start with the same first step of sectioning the face of the square, but this time the final 3D configuration will yield three identical modules instead of two. The three modules can form the basis for further sectioning into six smaller modules that can be articulated into open or closed chains. These chains will include a series of modules connected together by hinges made with transparent tape or drafting tape.

Given a square 4" x 4" and its modular grid, we draw a segmented line that divides the face of the cube into two separate parts (Fig. 8). This is the same first step as in the twin section process (Fig. 1.1).

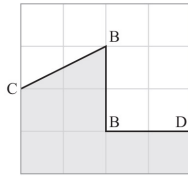

**Figure 8.** Two-part section.

Then we rotate one of the two resulting shapes by 180° with center in C so that the two shapes now share a boundary that is part of the edge of the square (Fig. 9). In addition to rotation, other operations such as translation movements along a straight line are possible in order to achieve the proper section. The students try various steps using tracing paper until a suitable configuration is found. The example shown is only one of many possible solutions.

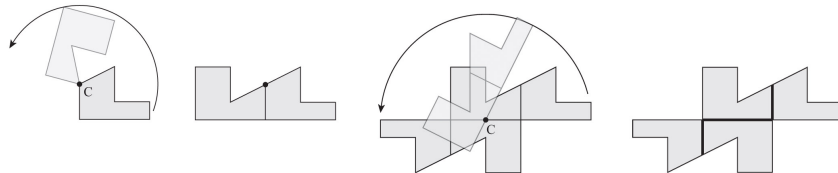

**Figure 9.** After one of the parts is rotated, the two shapes share one edge. The resulting shape is rotated by 180 degrees, resulting in the complete external surface of the module.

Another rotation of the new shape by 180° with center on another point C yields a total surface area of two squares. We then have four new parts, for a total of two squares that are arranged to share the whole or part of one of their original edges. It is a continuous four-part shape that occupies exactly one third of the external surface of the cube. The common boundaries shown as thick lines in Fig. 9 will be folded 90° in 3D space.

We repeat the process shown in Fig. 9 to obtain two additional shapes for a total of three identical shapes. We now have three shapes, made of four parts each, that comprise the full external surface of the cube (Fig. 10).

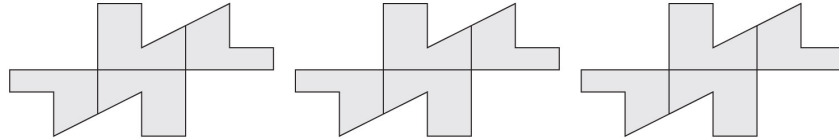

**Figure 10.** Complete external module.

With each shape, we fold and connect the parts along the shared boundaries and edges of the squares. The 90-degree folding will yield the three pieces of the puzzle, each exactly one third of the cubic space (Fig. 11). Each face is folded at 90 degrees. Three such modules will be fitted back together to form the cube.

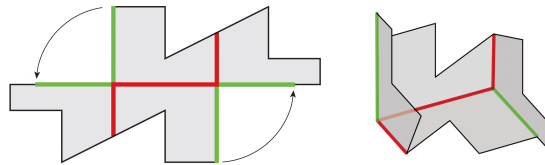

**Figure 11.** Folding the parts of a single module.

We now take the three identical modules forming the cube and we set them next to each other to make sure that they are identical in shape and orientation. The next step is to preserve the identity of the modules on the inside as it was on the outside. The triangular internal shapes of the modules need to be constructed in order to complete the full template.

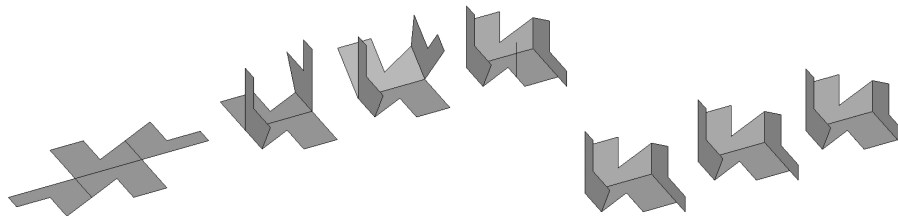

**Figure 12.** Folding of the single module and three modules side by side.

When constructing the three identical modules, we note that each face of the cube displays exactly the same original section or its mirror image, that each face has the same basic symmetry and spatial relationship with regards to the center of the cube, and that the external surface of each module is exactly one third of the total external surface of the cube. Each segment that is part of the original section will form the base of a triangle where the two other sides are lines connecting it with the center of the cube (Fig. 13). The process for determining the internal surface is identical for both the twin and triplet sections.

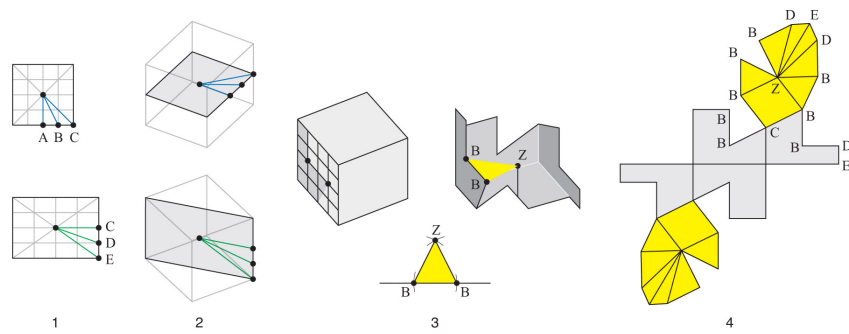

**Figure 13.** Construction of the internal triangles using the external line segments in combination with the lines provided by the cross-sections.

Sometimes two triangles will be combined into a diamond shape like the polygon BCBZ shown in Fig. 13.4 when the triangles happen to be coplanar in the final 3D model. The internal surface of each module will combine a series of triangles meeting at the center of the cube. Just as the external surface was the same for each of the three modules, the volume of each module is also the same.

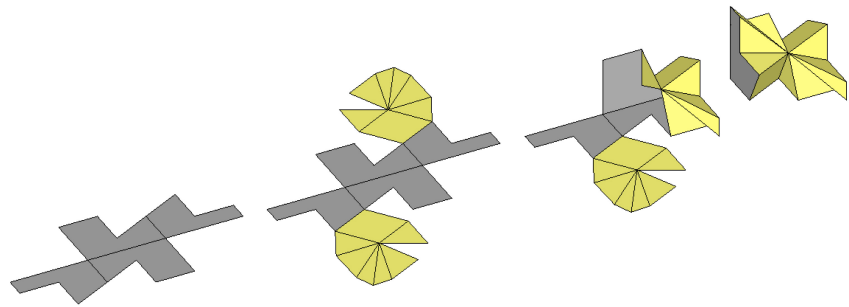
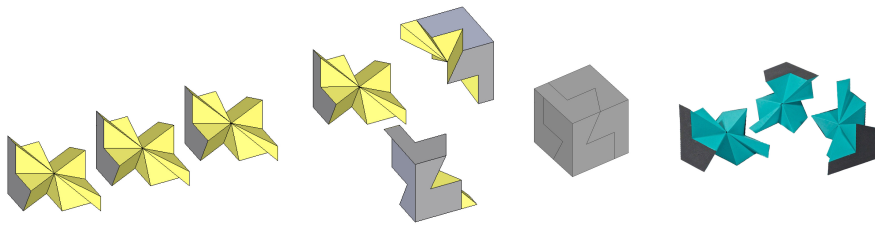

**Figure 14.** Folding sequence of one module.

Although advanced students would be able to determine the true dimensions of each triangle needed for the internal section by means of cross sections, this information is given to all students in the form of a “kit-of-parts” drawing where all needed lines have already been plotted. All students are required to build and test each surface needed for their cubes. The external surface is shown in gray and the internal surface is shown in yellow in the folding sequence depicted in Fig. 14.

To verify its exactness, a rough cube can now be constructed out of card stock and scotch tape. A second and more refined cube will be made with high quality cover stock and white glue. A color is used for the outside surface and a different color for the inside surface. All modules are identical and right-handed. A combination of blue and yellow board is used later in the six-module version of the cube shown in Fig. 15.

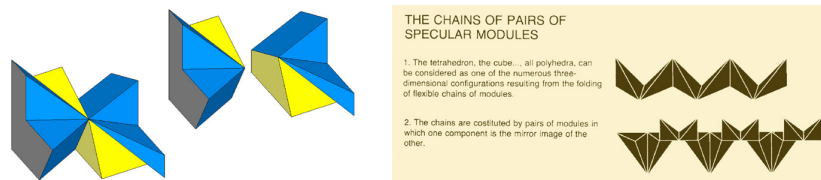



**Figure 15.** The three modules and the completed cube. Cube made with card stock and glue.

### C. HINGES AND ROTATIONS

In the three-module cube shown in Fig. 15, before they were hinged together, the modules were further sectioned in half (Fig. 16). This additional division can be helpful when the three finished modules cannot fit back together because of collisions due to “undercuts” present in the design of the section. In these cases, the additional division frees the parts and allows them to fit back together. When the one-third module is split in half, the resulting one-sixth modules are again identical to each other.



**Figure 16.** One-third module is split into two parts. At right: illustration from *Modelli di Geometria Rotatoria*.

The modular chains built by Scarpa are formed by pairs of mirrored modules hinged together along repeating axes, as seen on the right in Fig. 16, which shows an illustration from page 62 of his book (Scarpa 1978).

In the final examples shown in Fig. 19 and Fig. 20 it was possible to articulate the chain even though the modules are not mirrored. Rather, all the modules have exactly the same shape and orientation. The modules in this chain are analogous to two right hands: they can be moved one over the other and look exactly the same. The six modules, shown also in exploded view in Fig. 17, are then hinged together to form a cube.

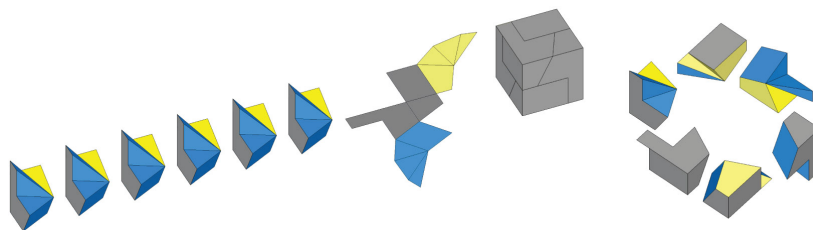

**Figure 17.** The new six modules, with the internal surface in yellow and the external surface in blue. At right is the exploded view of the six modules forming the cube.

The six modules will be hinged together along the cube's diagonals and other lines on the faces of the cube. The hinges are shown as thick black lines in the "x-ray" view on the left in Fig. 18. Four such groups are connected together in the "closed-chain" configuration used for the physical model seen in Fig. 19 and Fig. 20.

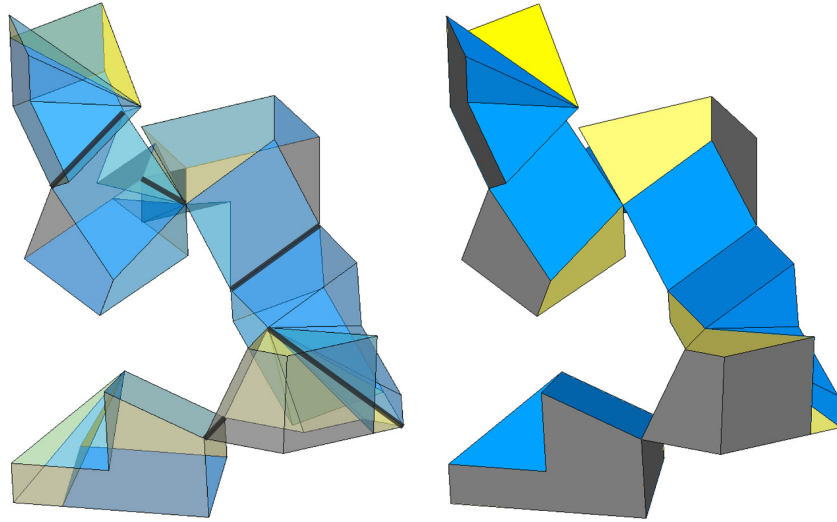

**Figure 18.** The six modules that will form a cube are hinged together along the thick black lines.

### Configuration 1

A series of four cubes including a total of 24 modules was hinged together using a combination of hinge locations as shown in Fig. 18. In the configuration shown in Fig. 19 the selected placement of the hinges produced a closed chain where the modules cannot fold back into their minimal volume of  $2 \times 2 \times 1$  cubes. The minimal volume is not an absolute requirement and various configurations can be tested to achieve different results. This chain is composed of 24 identical modules. Each module occupies one-sixth of one cube. Four complete cubes compose the chain.

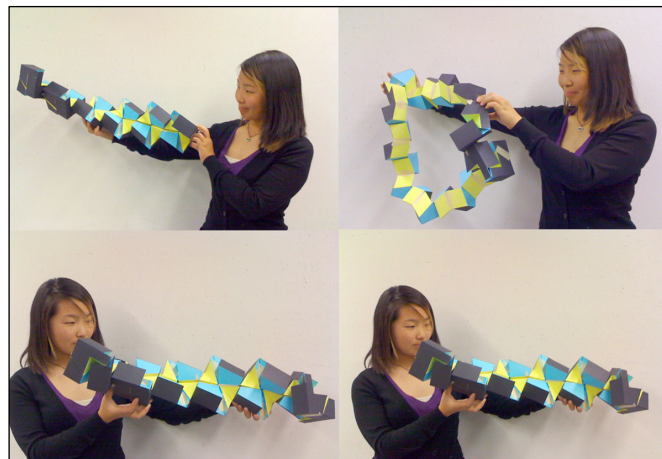
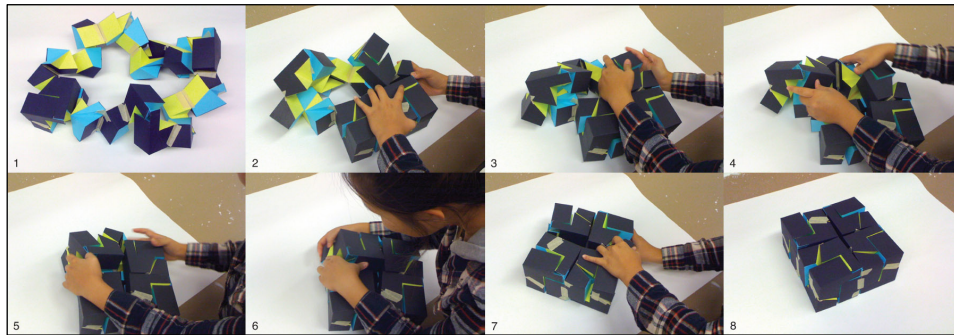

**Figure 19.** Twenty-four modules. This configuration does not fold back into a cubic shape.

## Configuration 2

The next configuration allows the four cubes to fold back into their minimal volume of  $2 \times 2 \times 1$  cubes. The location and spatial orientation of the hinges needs to be formalized and mapped. We can expand this configuration into a larger volume composed of eight cubes, having 48 modules hinged together in a similar sequence. Physical models as well as computer simulations can be built to test  $2 \times 2 \times 2$  configurations.

The initial section of the square is complex enough that it makes it difficult for the modules to easily fold back together. Hand pressure is used to guide the modules together. With simpler designs it is possible to achieve the reassembling of the modules with little force. Simpler shapes are more “cooperative” in transmitting the pressure applied at one point of the chain to the other points along the chain. The same 24 modules seen in Fig. 19 were used to create the chain shown in Fig. 20, which collapses back into a  $2 \times 2 \times 1$  cubic space.



**Figure 20.** Twenty-four modules. This chain folds back into a minimum cubic space of  $2 \times 2 \times 1$ .

## Observations

Given a simple initial section on a face of a solid, it is possible to develop complex three-dimensional solids by rotating and folding the resulting parts. In principle, any initial section should work for the division of the cube in two or three modules, but is there a formal approach that can determine the degree of complexity of the final modules based on any initial section? In order to formalize the operation, collaboration is needed between designers, mathematicians, and engineers to tackle the theoretical aspects of the problem, however the modules can still be built without sophisticated mathematical knowledge. Finally, all regular solids and convex regular polyhedra should yield modular divisions of this kind.

The progression from a simple section of a square to a complex articulated modular chain presents a series of geometric transformations that can be appreciated on many levels: aesthetic, mathematical, and biological. Scarpa notes that the progressive division of solid forms into smaller and complementary modules might represent a valid model for biological systems. One such system of particular interest is the little known mechanism of protein folding and many believe that geometry may hold a key to understanding this process (Demaine and O'Rourke 1997).

## Pedagogical value

Drawing can be taught in many ways, this unit adds the discovery of form, space, and geometric transformations to the basic skills of learning to see and learning to draw. It strengthens the connection between nature and man-made by pointing to an essential aspect of life: movement. Scarpa points out the parallels between nature and rotational geometry. Mirroring, rotations, translations, folding, are all geometric movements. Straight lines and linear motion seem to be less frequent in nature than rotational motion: plants, planets, shells, dancing bees, to name a few, all move and grow along curved paths, sometimes spinning and turning around themselves.

Stimulated by works such as *On growth and form* by D'Arcy Wentworth Thompson (Thompson 1942) artists and designers like Scarpa have had an opportunity to explore nature and geometry as two complementary domains. The painter Paul Klee, whose pedagogical writings constitute one of the early inspirations for Scarpa's work on geometry and topology, noted that: "The artist cannot do without his dialogue with nature, for he is a man, himself of nature, a piece of nature and within the space of nature (Klee 1970, p. 6)." Scarpa points out the difficulty in observing nature, which grows from the inside outwards, but we can only observe it from the outside and thus sometimes miss its internal generative processes.

The basic processes used to produce the 2- and 3-module configurations can be described as general processes, almost natural ones. Teaching the skill of drawing and learning how to see through these hands-on processes enrich the learning experience beyond formal technical instruction. They expose the students to a model of discovery and design process that can later be used in more applied design projects.

The unit thus focuses on non-applied problems, even if the design solutions that are generated by the general problems have very definite, physical shapes. The final models constructed by the students are the physical summary of the design process and function as the tangible products and outcome of the process itself.

## Conclusion

This teaching unit, using the principles of Rotational Geometry, can be integrated into the art and design classes of high schools and art foundation courses of art colleges. Through the process of manipulating two-dimensional shapes and their transformations, students build three-dimensional modules and learn the intimate relationship between the two domains: 2D and 3D. This hands-on process returns many benefits, such as the ability to quickly visualize objects in three-dimensional space when the students move on to computer aided design processes that use AutoCAD and other 3D software. The unit includes elements of drawing, learning to see, transformations, and affords parallels with other disciplines such as mathematics, geometry, and biology. It represents a bridge between the aesthetic and the mathematical components of a geometry problem, its artistic and humanistic component, and its scientific component.

**Acknowledgements:** Thanks to my former student Florence Gold Yuen at San Francisco State University for building the physical models shown in Fig. 19 and Fig. 20. The 3D illustrations shown in the article are based on those models. **Figures:** Source for all illustrations and photos included in the paper: Author 2012, except Fig. 16 (right): Source: Scarpa 1978, p. 62.

## References

- Demaine, Erik D., and Joseph O'Rourke. *Geometric folding algorithms. Linkages, origami, polyhedra*. Cambridge: Cambridge University Press, 1997.
- Klee, Paul. *Notebooks volume 2 The nature of nature*. Edited by Jürg Spiller. Translated by Heinz Norden. New York: Wittenborn, 1970.
- . *The thinking eye*. Edited by Jürg Spiller. Translated by Ralph Manheim. New York: Wittenborn, 1961.
- Munari, Bruno. *Design e comunicazione visiva*. Bari: Laterza, 1974.
- Scarpa, Giorgio. *Modelli di geometria rotatoria*. Bologna: Zanichelli, 1978.
- Thompson, D'Arcy Wentworth. *On growth and form*. Cambridge: Cambridge University Press, 1942.